

## DOCCIA IDROMASSAGGIO

In questo manuale è illustrata la procedura di montaggio della **cabina doccia idromassaggio** Atene. Prima di montare il **box doccia** consigliamo di consultare il presente manuale di istruzioni per realizzare il montaggio correttamente.

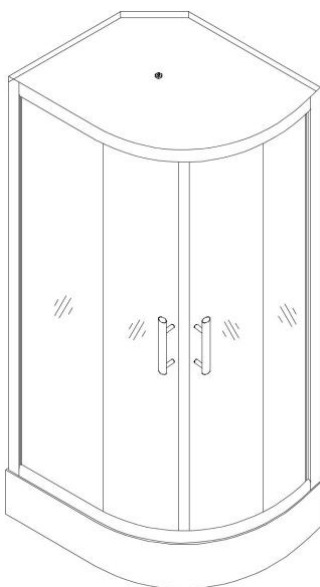

Per visionare tutti i modelli di **docce idromassaggio** visita la sezione

[DOCCIA IDROMASSAGGIO](#)

CABINA IDROMASSAGGIO  
**ATENE**

La **cabina multifunzione** Atene è disponibile nelle seguenti misure:

[BOX DOCCIA IDROMASSAGGIO](#)  
120x80x218DESTRA

[BOX DOCCIA IDROMASSAGGIO](#)  
120X80X218SINISTRA

Il **box doccia idromassaggio** Atene è disponibile anche nella versione con il bagno turco integrato, clicca il link per vedere il prezzo

[DOCCIA BAGNO TURCO](#) 120X80X218 SINISTRA

[DOCCIA BAGNO TURCO](#) 120X80X218 DESTRA

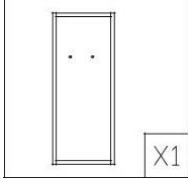
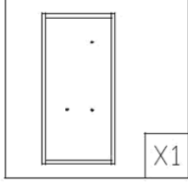
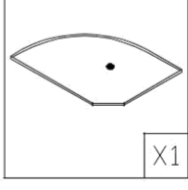
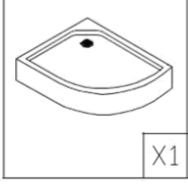
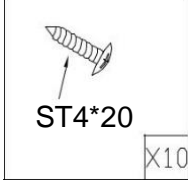
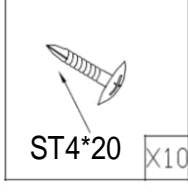
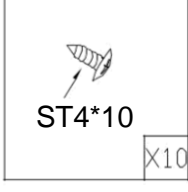
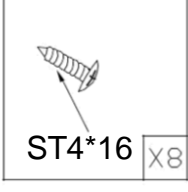
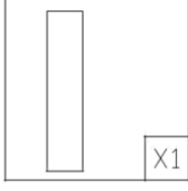
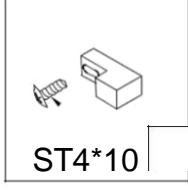
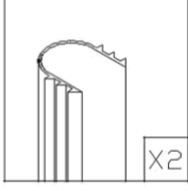
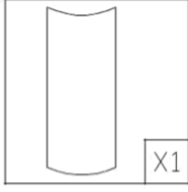
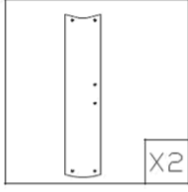
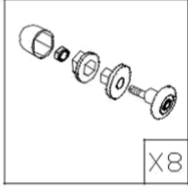
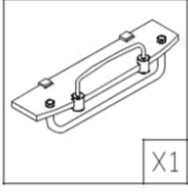
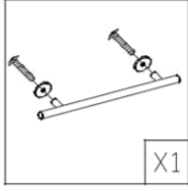
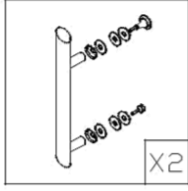
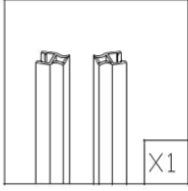
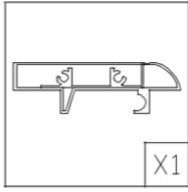
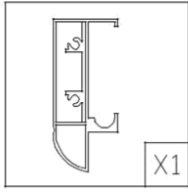
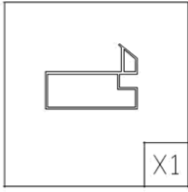
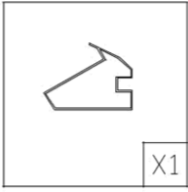

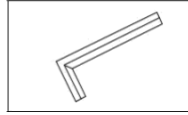
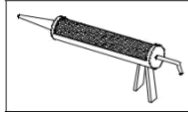
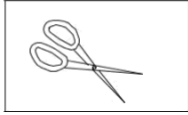
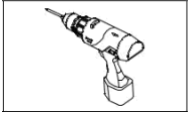
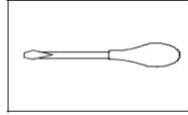
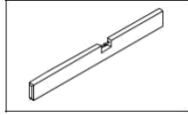
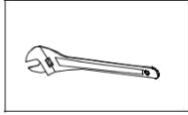
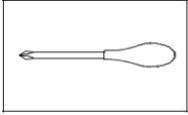

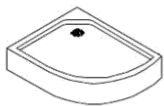

X1

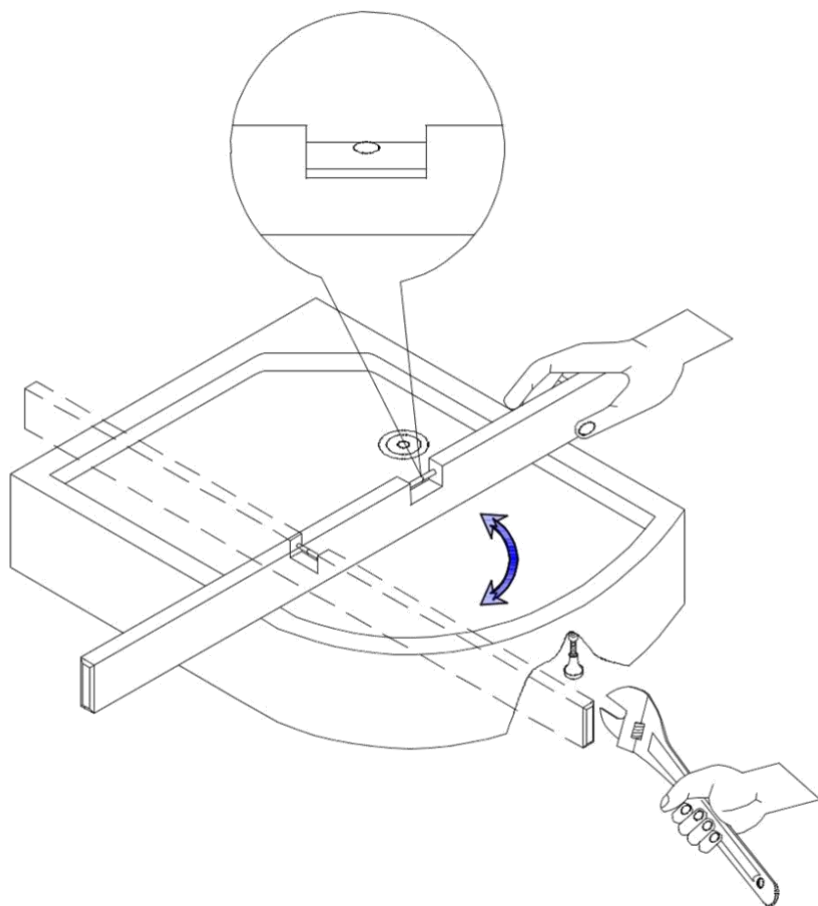
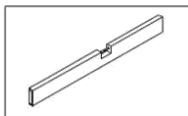
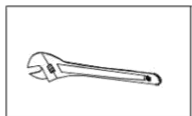



X1



X1

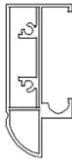

X1

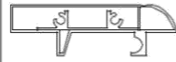

X1



ST4\*16

8

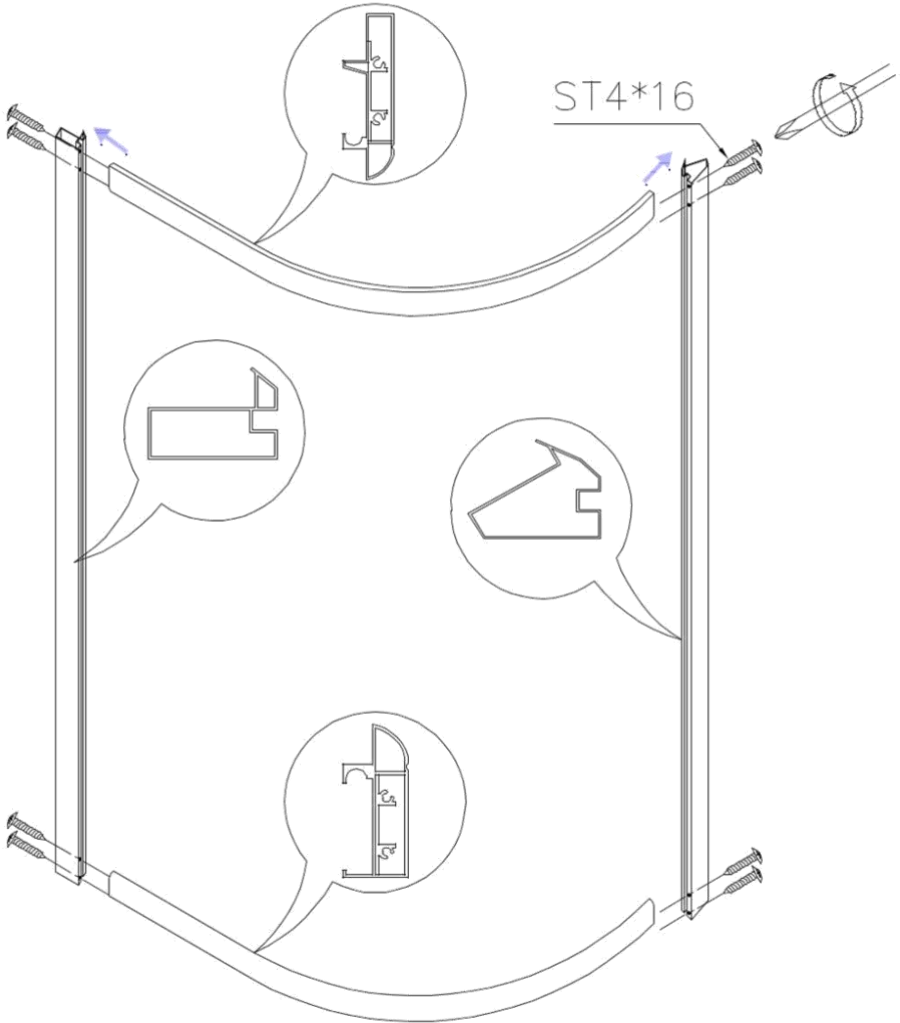

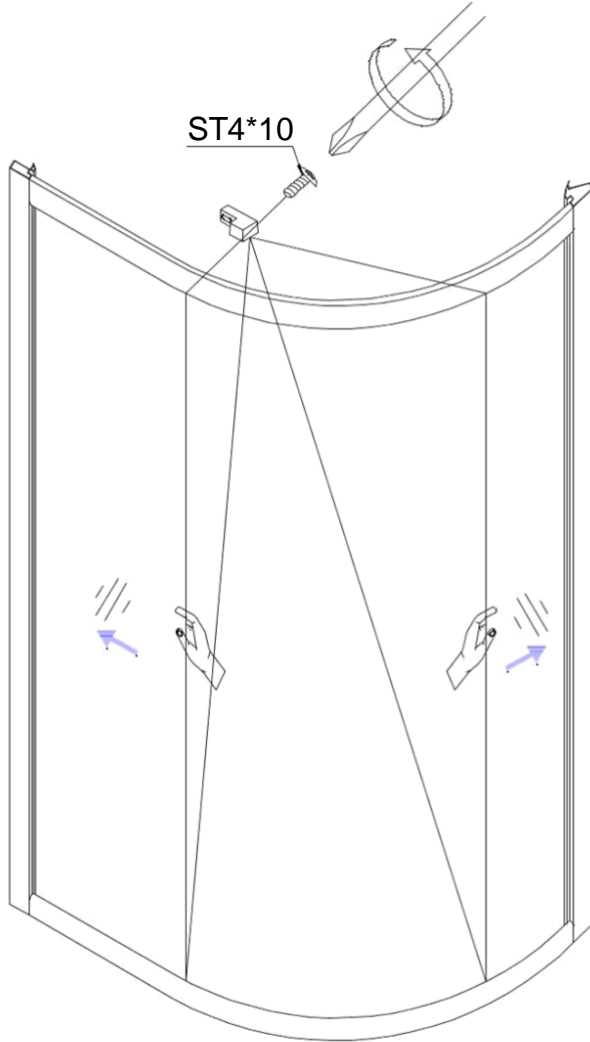
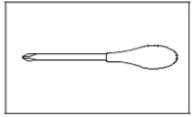
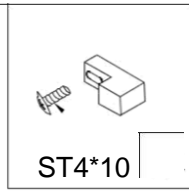
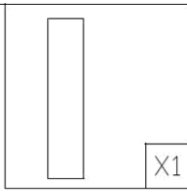
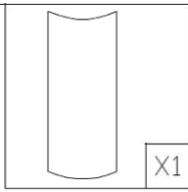
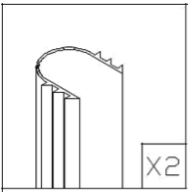

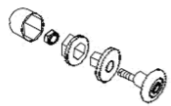

X8



X2

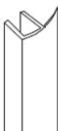

X2

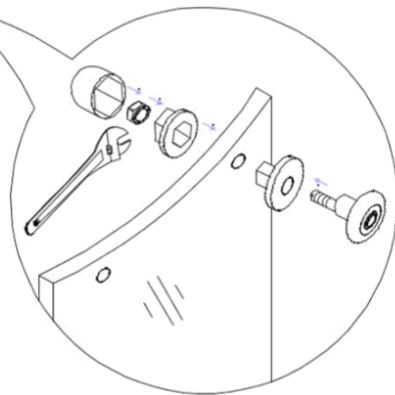
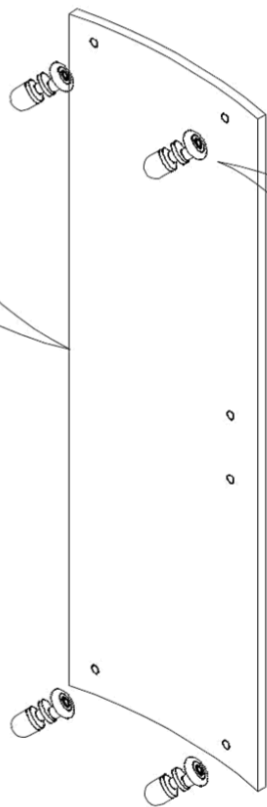
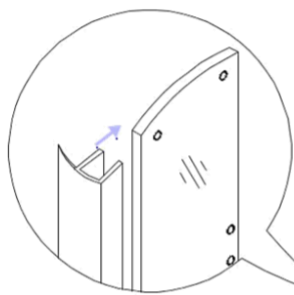
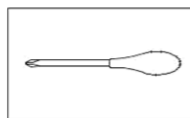



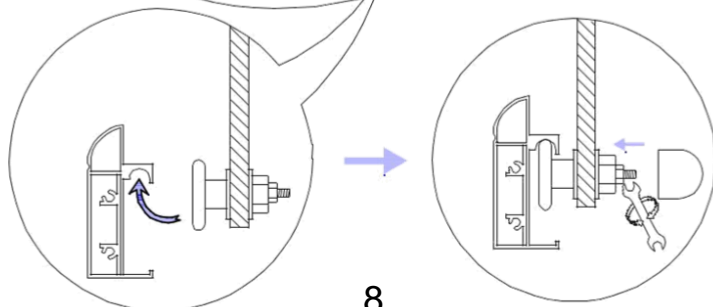
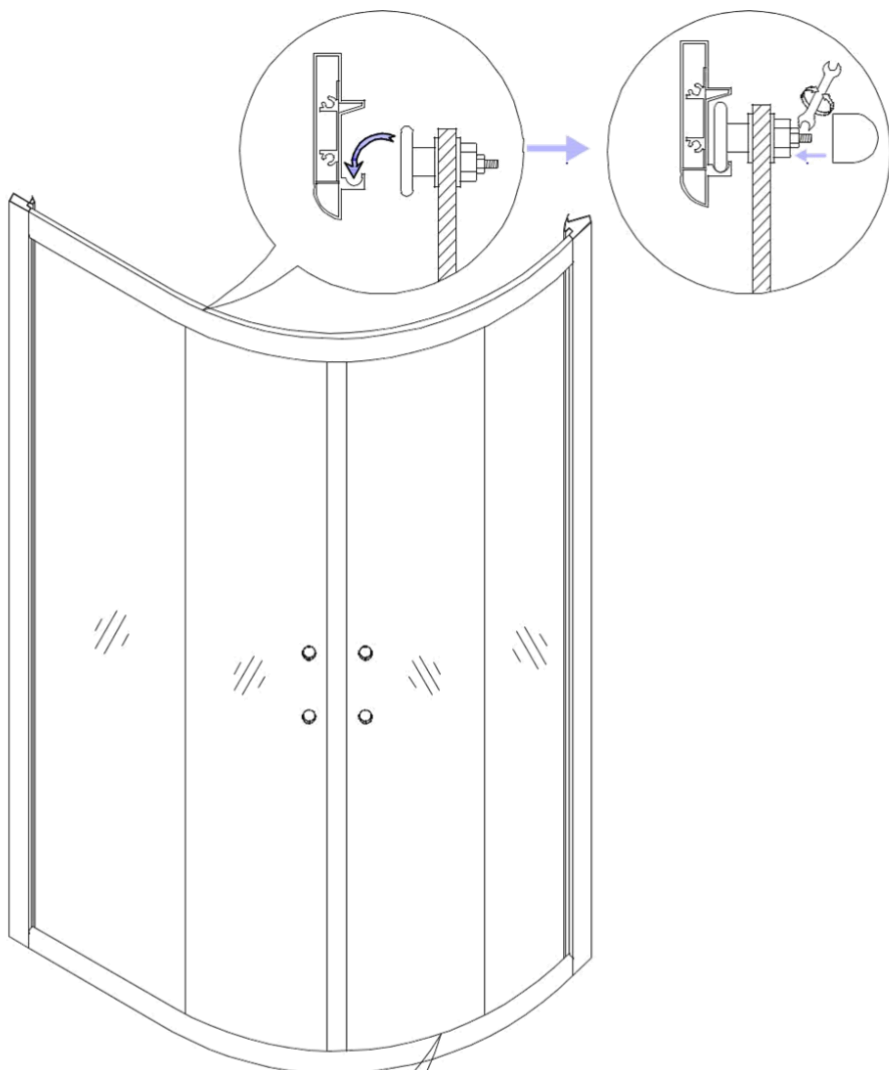



X2

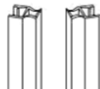

X1

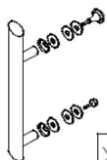

X2

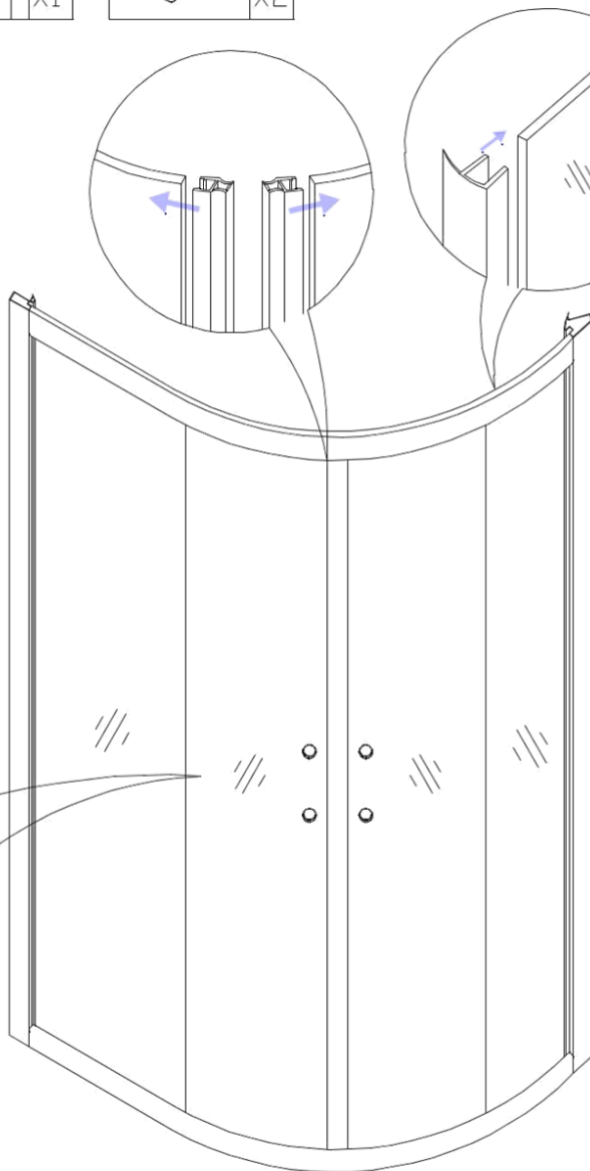
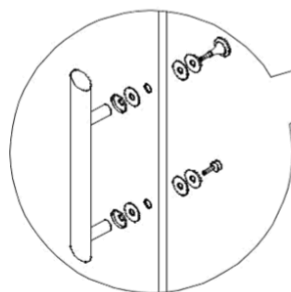
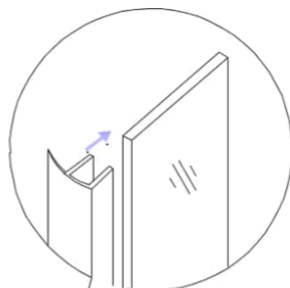
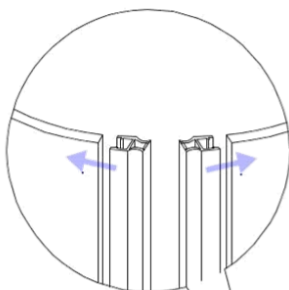



X1



X1



ST4\*10

X10

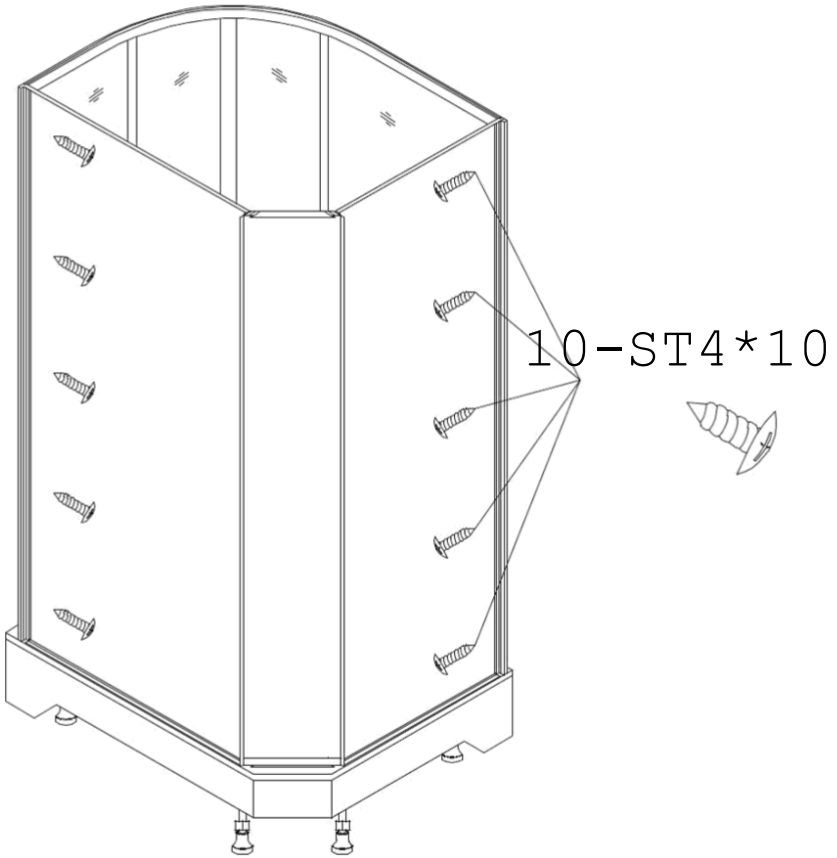
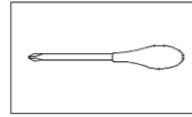



ST4\*20

X10

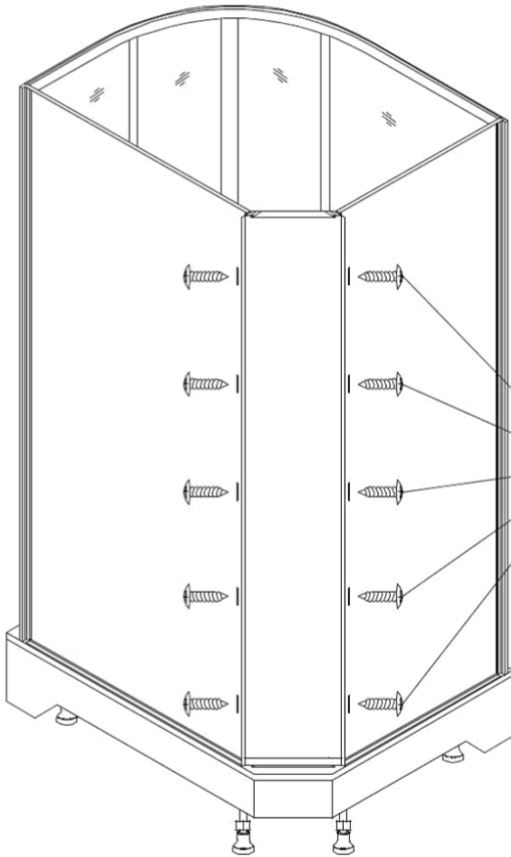
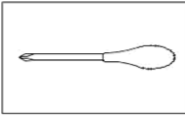

10-ST4\*20



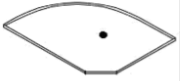

X1



ST4\*20

X10

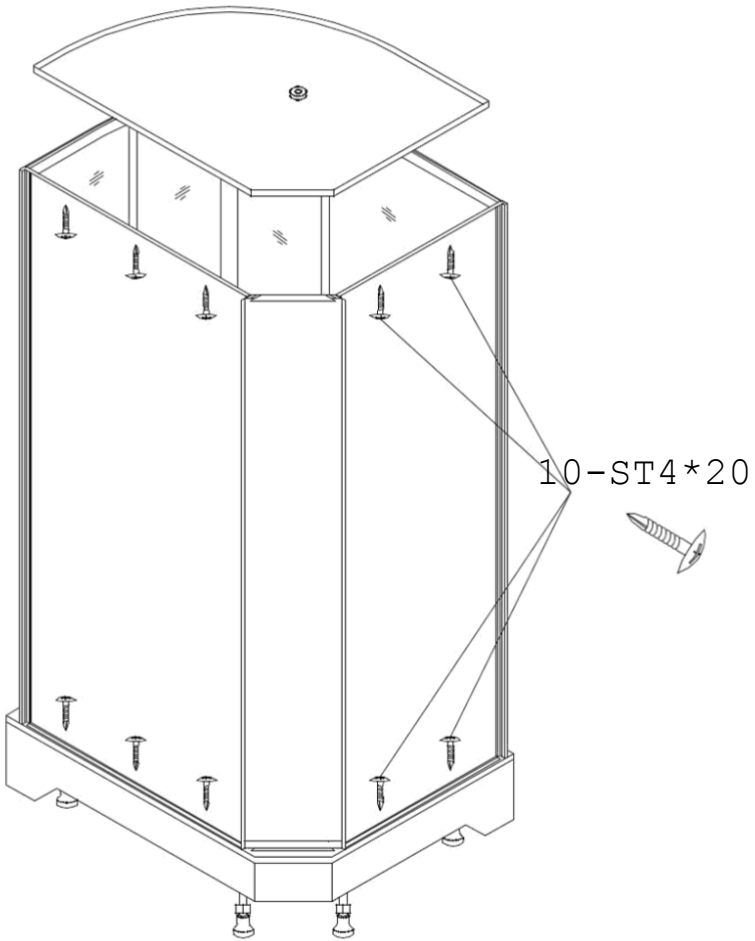
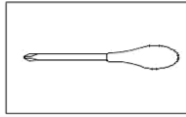

10-ST4\*20

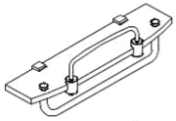

X1

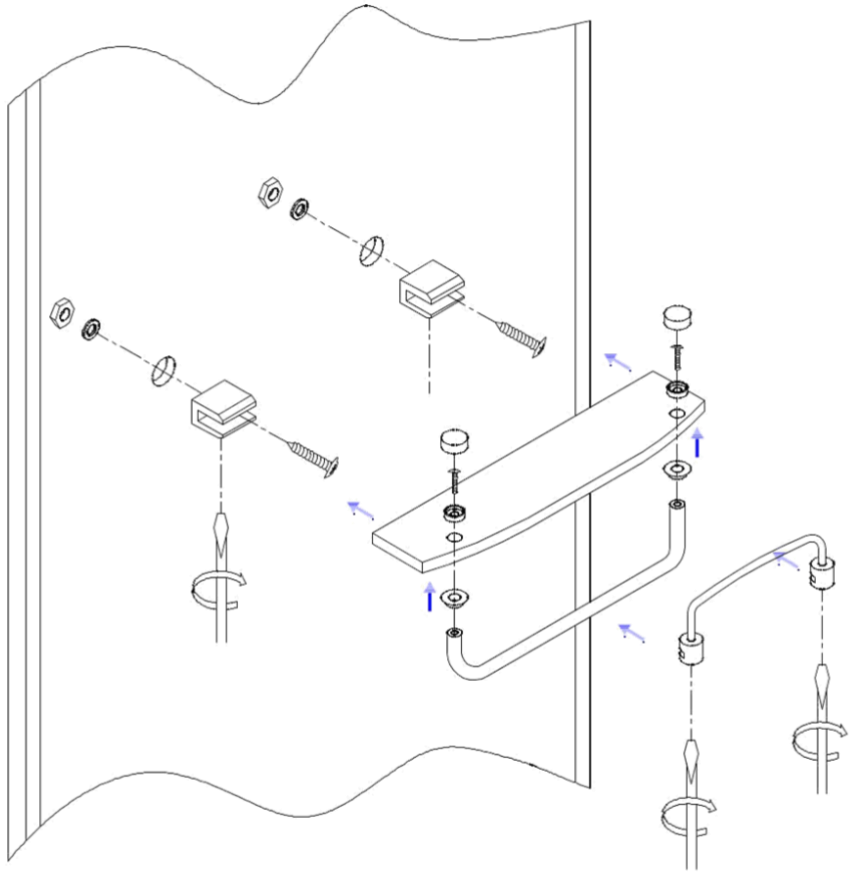
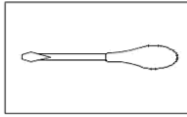
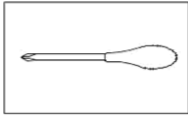

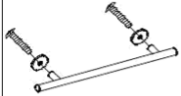

X1

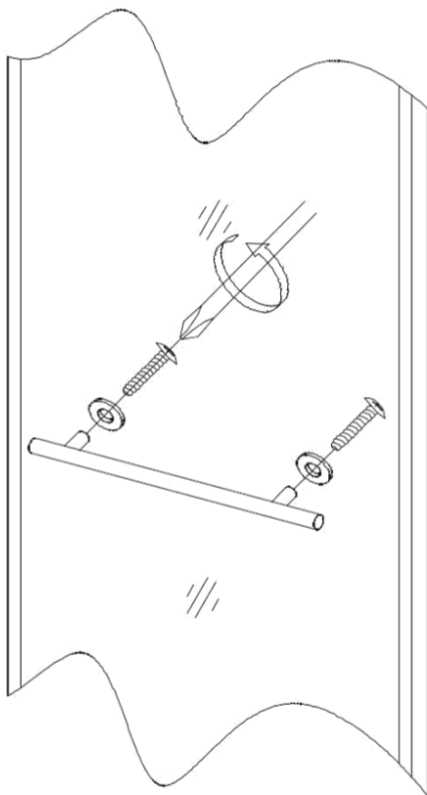
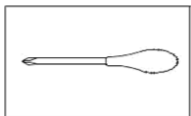

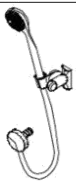

X1

