

VASCA DOCCIA IDROMASSAGGIO

BLUSKY

In questo manuale è illustrata la procedura di montaggio della **vasca doccia idromassaggio** Blusky.

Prima di montare la **vasca doccia idromassaggio** consigliamo di consultare il presente manuale di istruzioni per realizzare il montaggio correttamente.

Per visionare tutti i modelli di **vasca doccia idromassaggio** visita la sezione

[DOCCIA IDROMASSAGGIO](#)

VASCA DOCCIA IDROMASSAGGIO
BLUSKY

La **vasca doccia idromassaggio** Blusky è disponibile nella seguente versione:

[VASCA DOCCIA IDROMASSAGGIO](#)
90X90X210

1/4

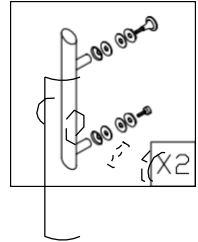
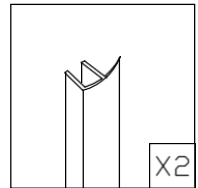
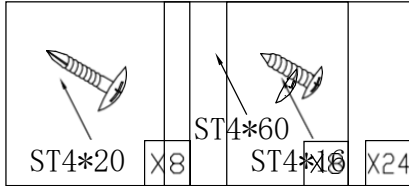
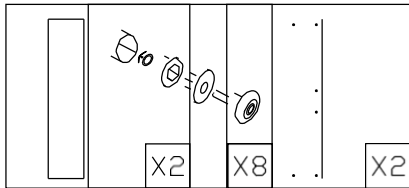
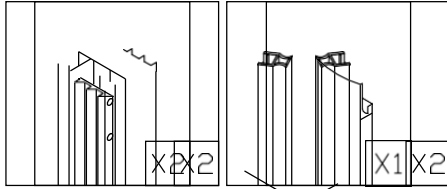

والتعليق

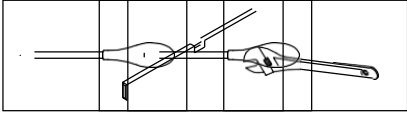

11

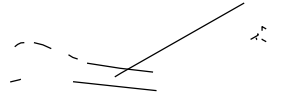

2

2/4

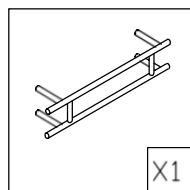
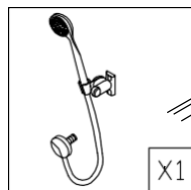
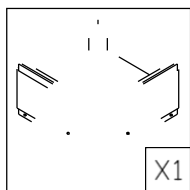
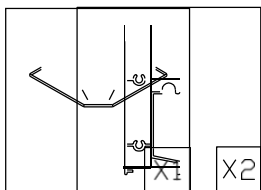

3/4

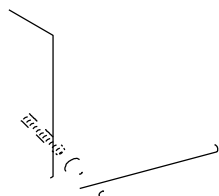
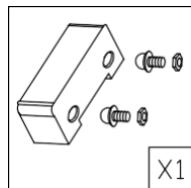
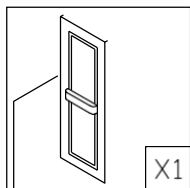
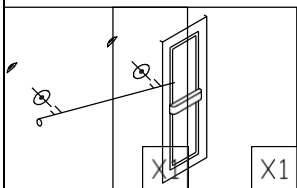

4/4

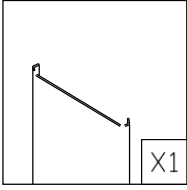

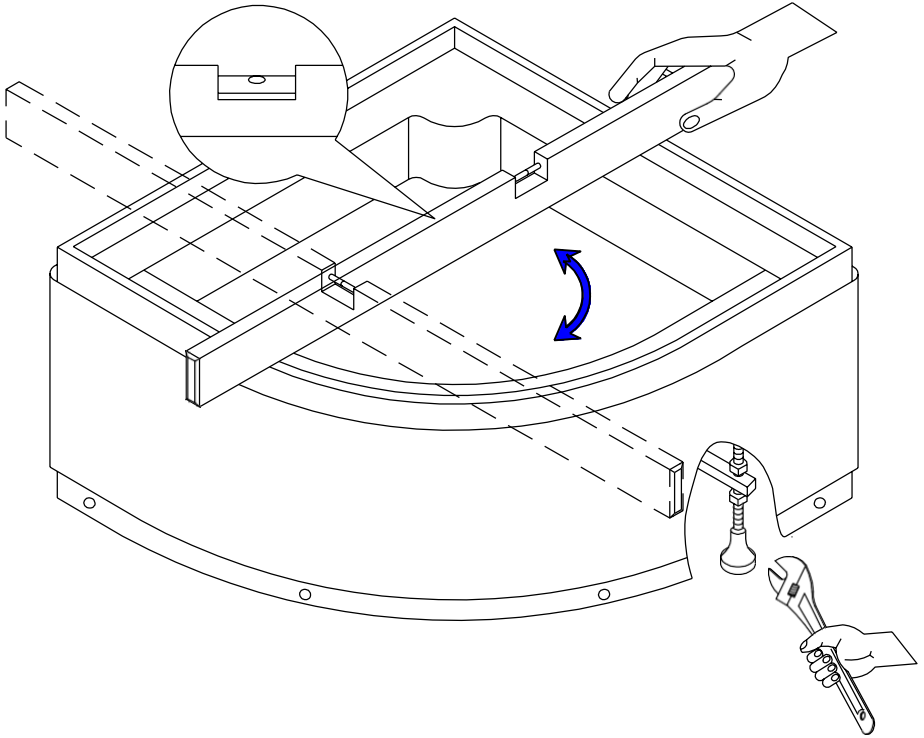
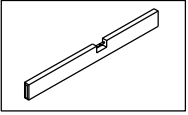
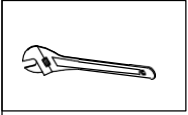

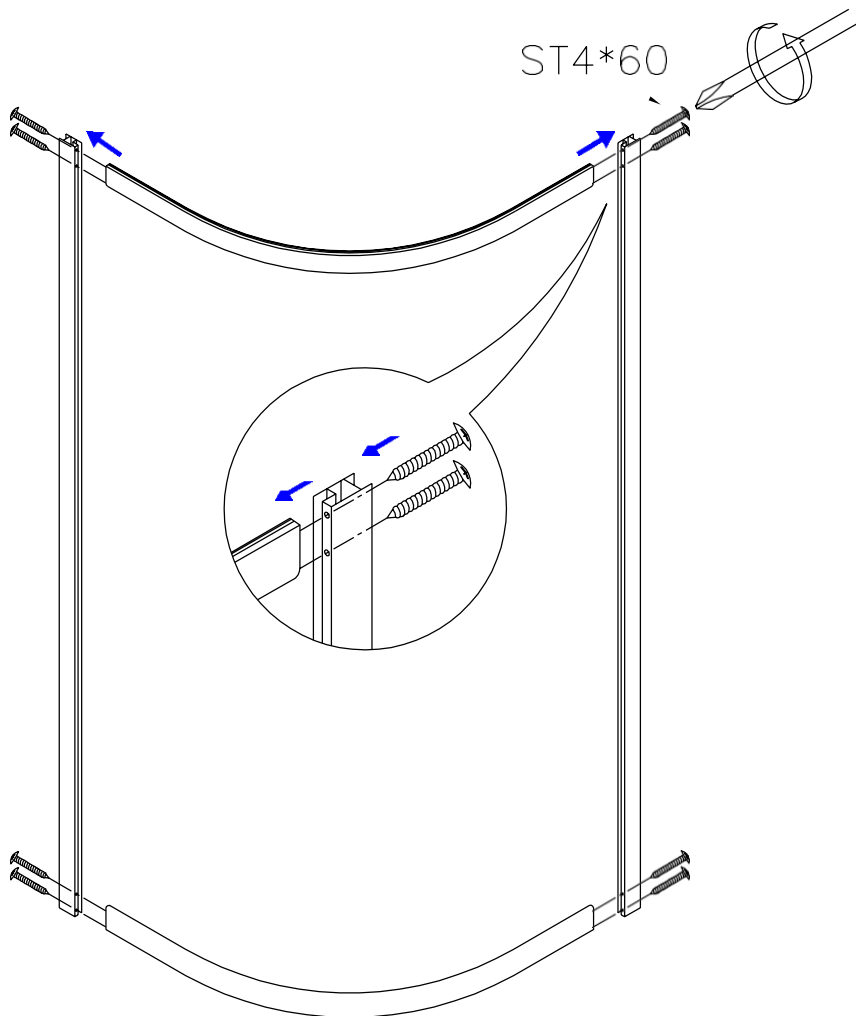
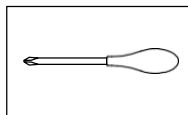
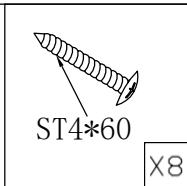
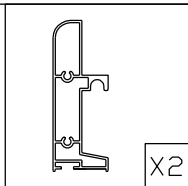
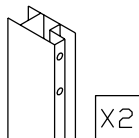

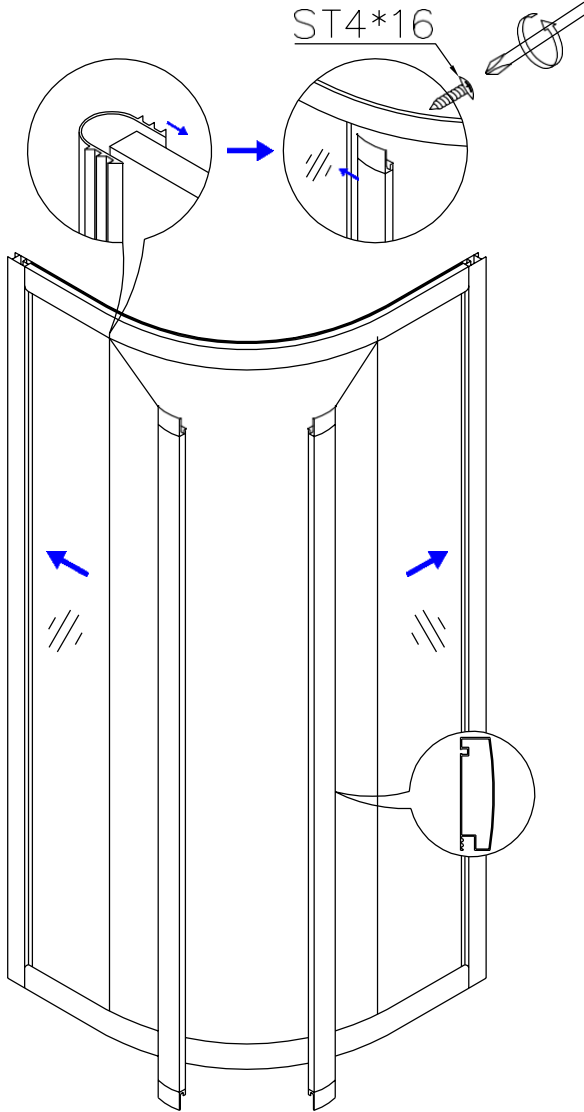
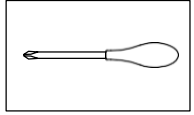
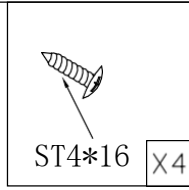
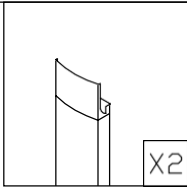
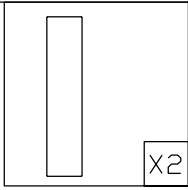
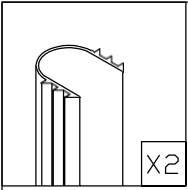

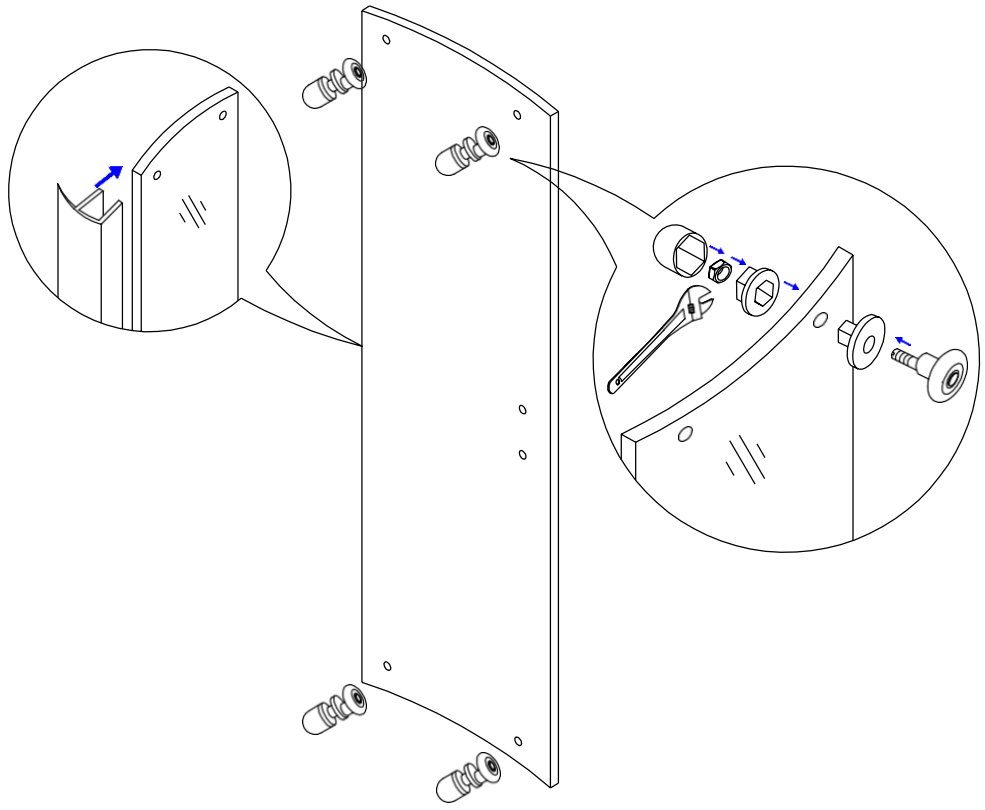
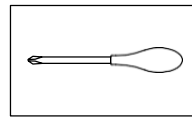
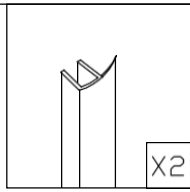
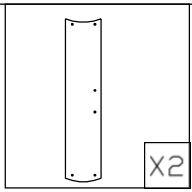
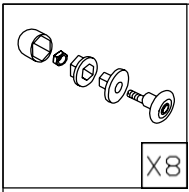

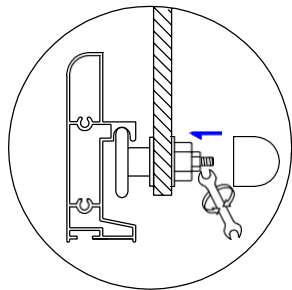
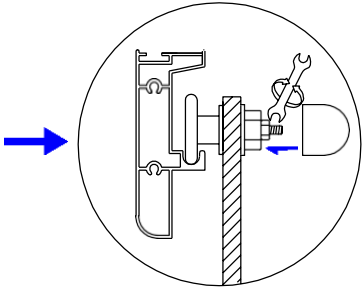

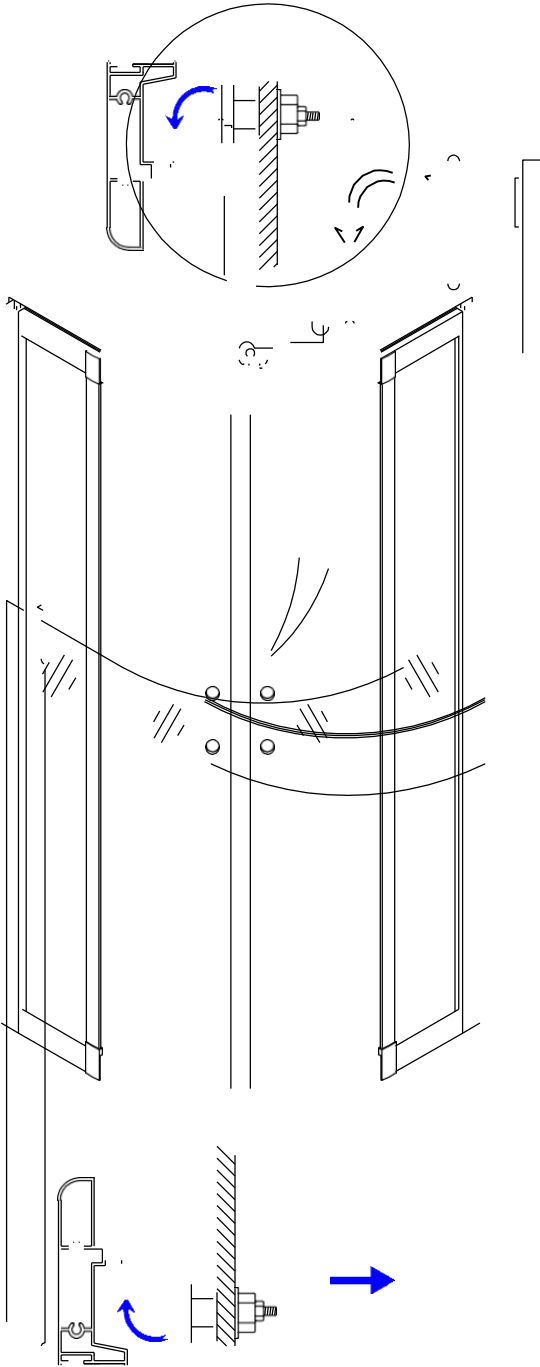

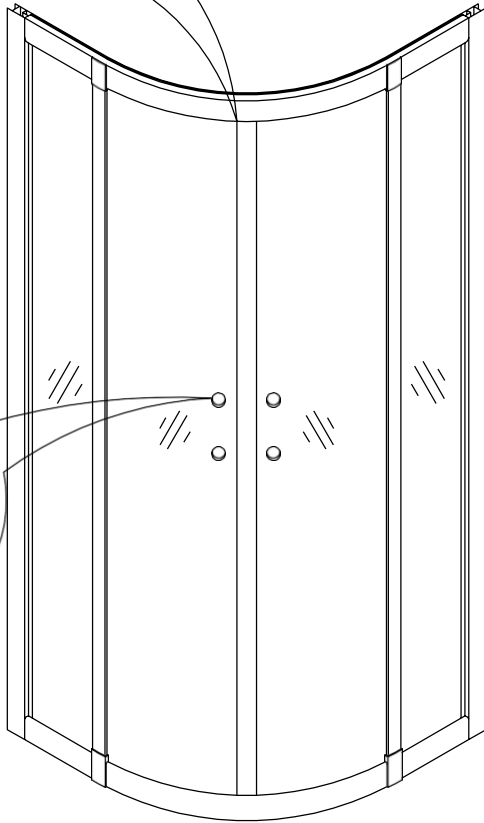
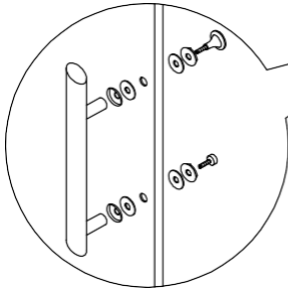
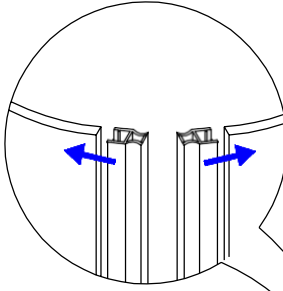
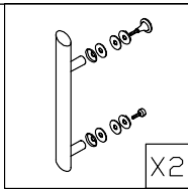
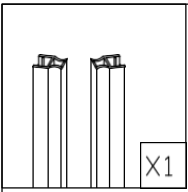

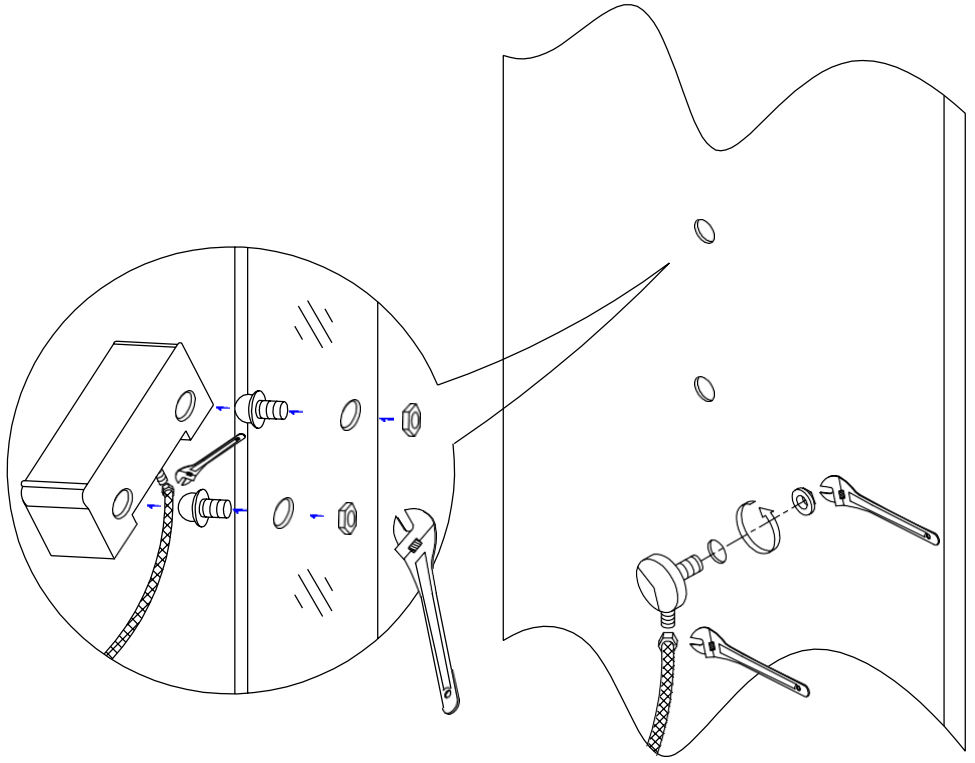
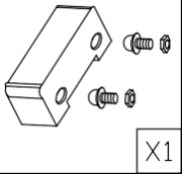



X1

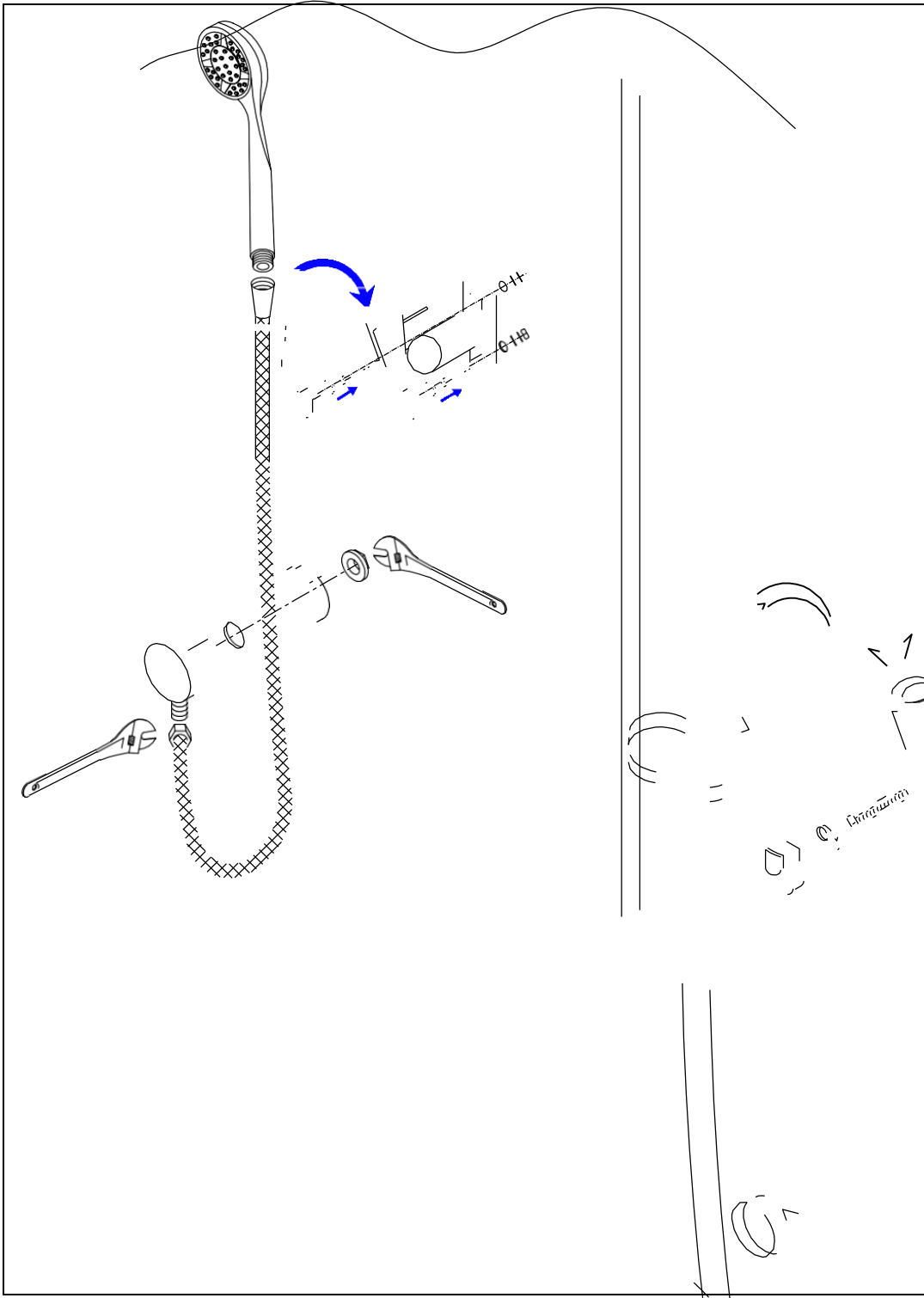

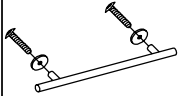

X1

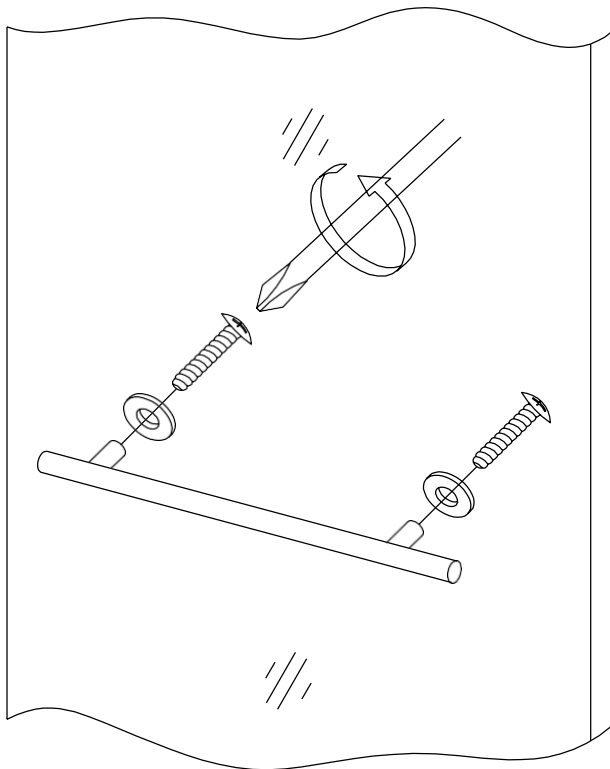
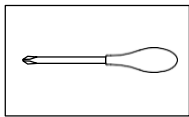

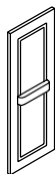

X1

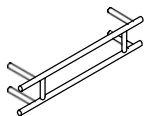

X1

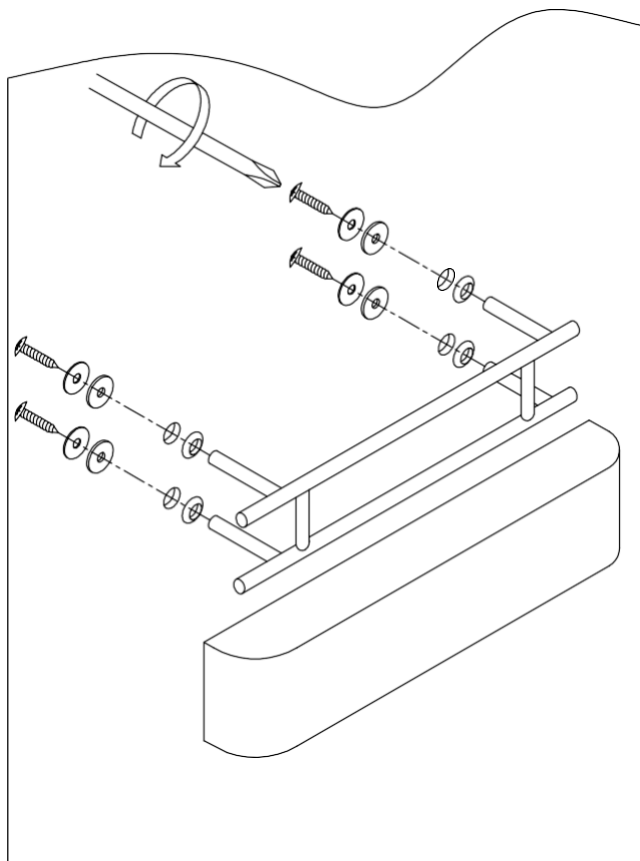
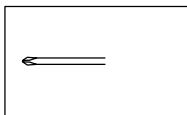



ST4*16

X10

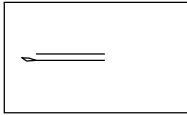

10-ST4*16

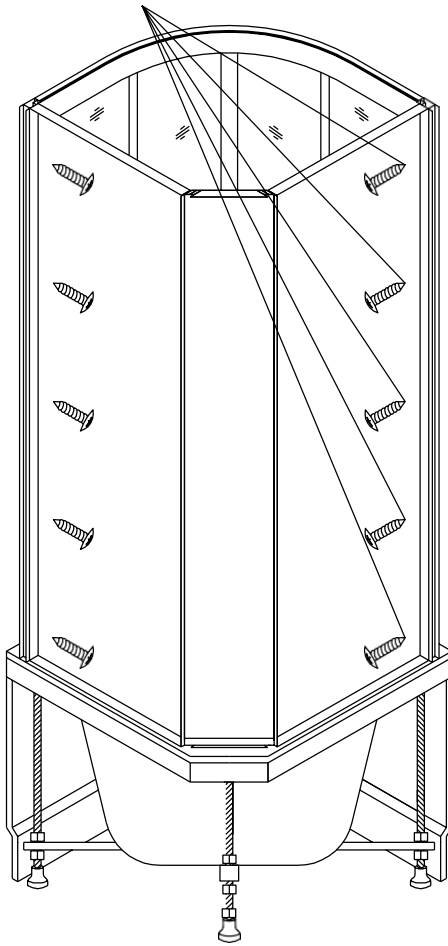



ST4*20 X8



ST4*16 X10

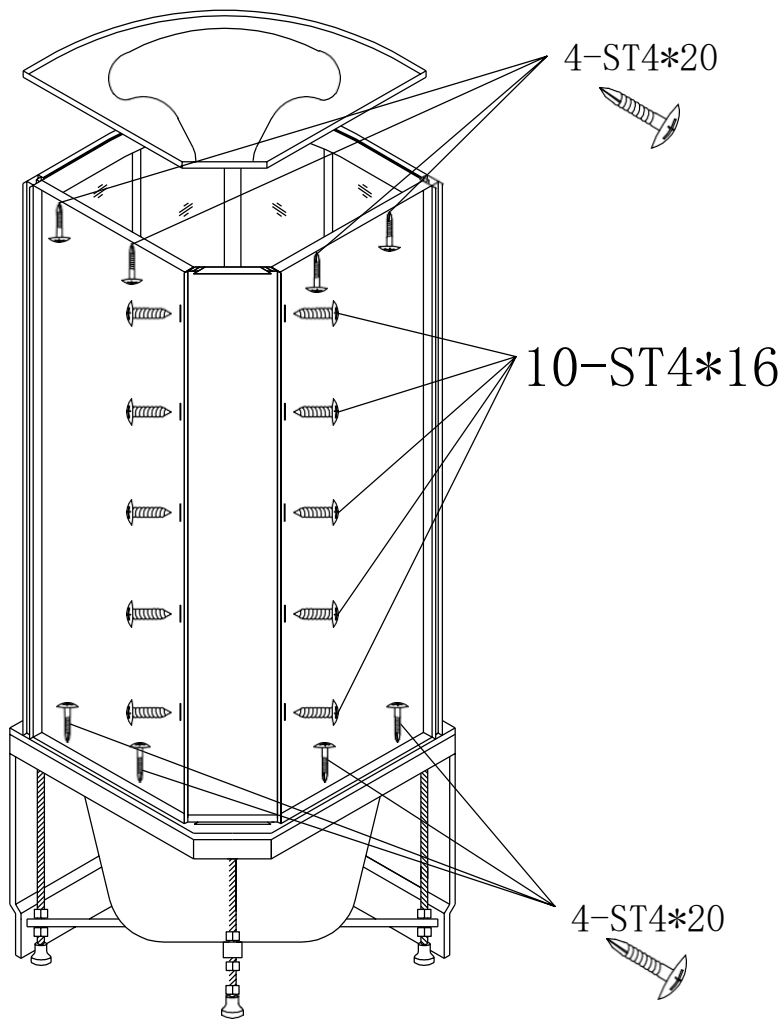
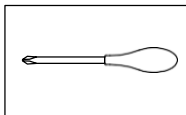

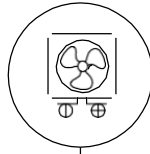
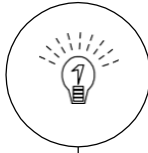
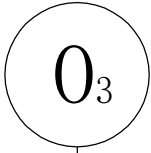

Λ

- ,



-

