

VASCA DOCCIA IDROMASSAGGIO

POLO NORD

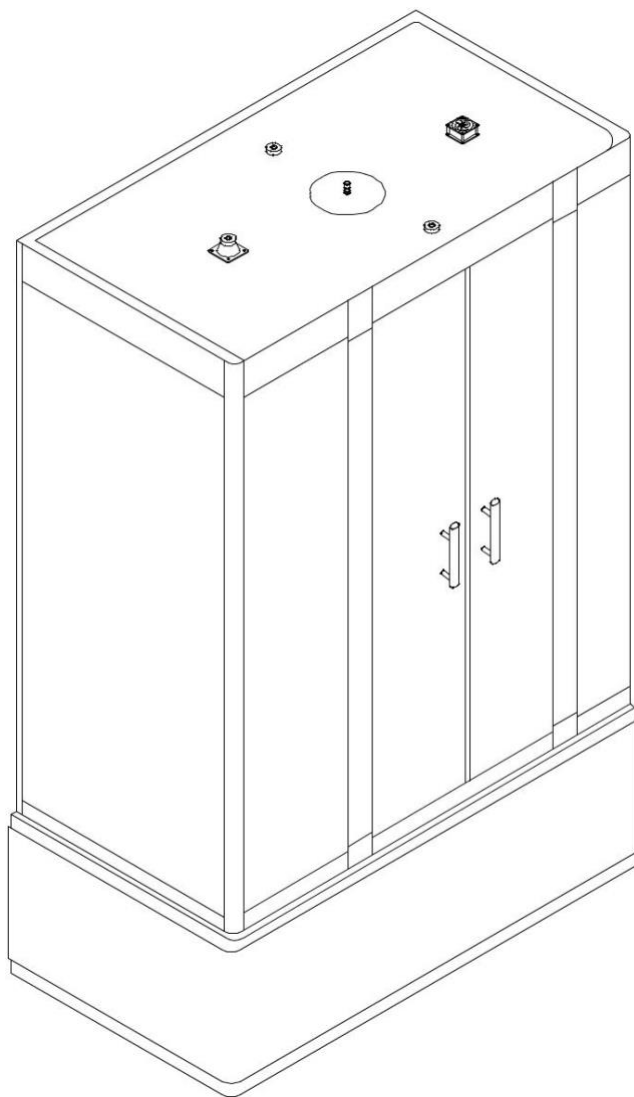

In questo manuale è illustrata la procedura di montaggio delle **vasche doccia combinate** Polo Nord. Prima di montare la **vasca doccia** consigliamo di consultare il presente manuale di istruzioni per realizzare il montaggio correttamente.

Per visionare tutti i modelli di **vasca con doccia idromassaggio** visita la sezione

[DOCCIA IDROMASSAGGIO](#)

VASCA DOCCIA IDROMASSAGGIO POLO NORD

La **vasca con doccia idromassaggio** Polo Nord è disponibile nelle seguenti versioni:

[VASCA DOCCIA IDROMASSAGGIO](#)
160x850x215

[VASCA DOCCIA IDROMASSAGGIO](#)
160X85X215 BAGNO TURCO

1/4

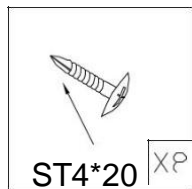
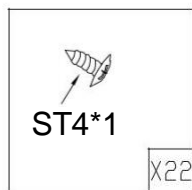
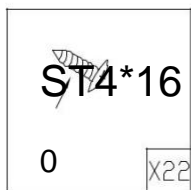
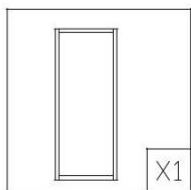
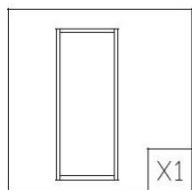
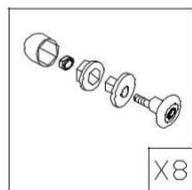
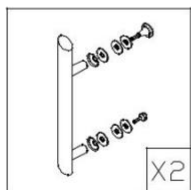
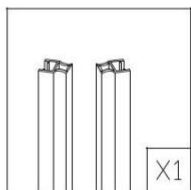
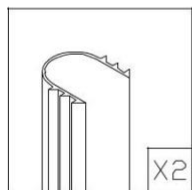
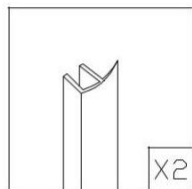
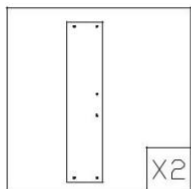
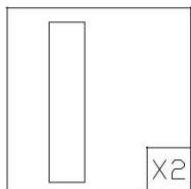
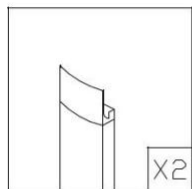
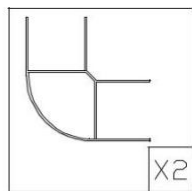
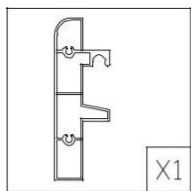
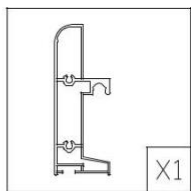
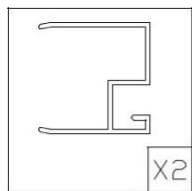
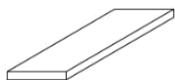

2/4

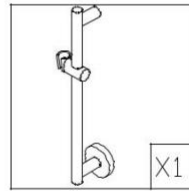
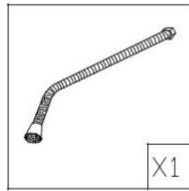
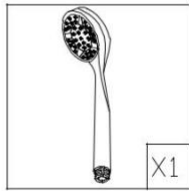
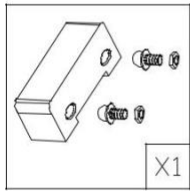
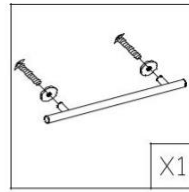
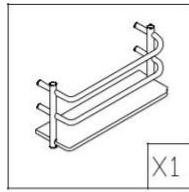
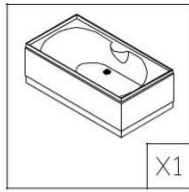
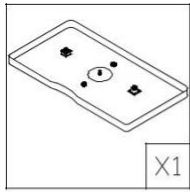
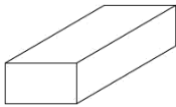

3/4

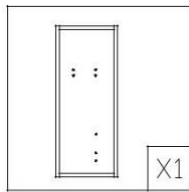
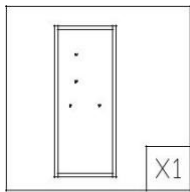
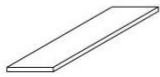

4/4

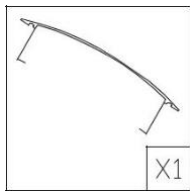
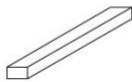

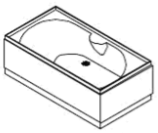

X1

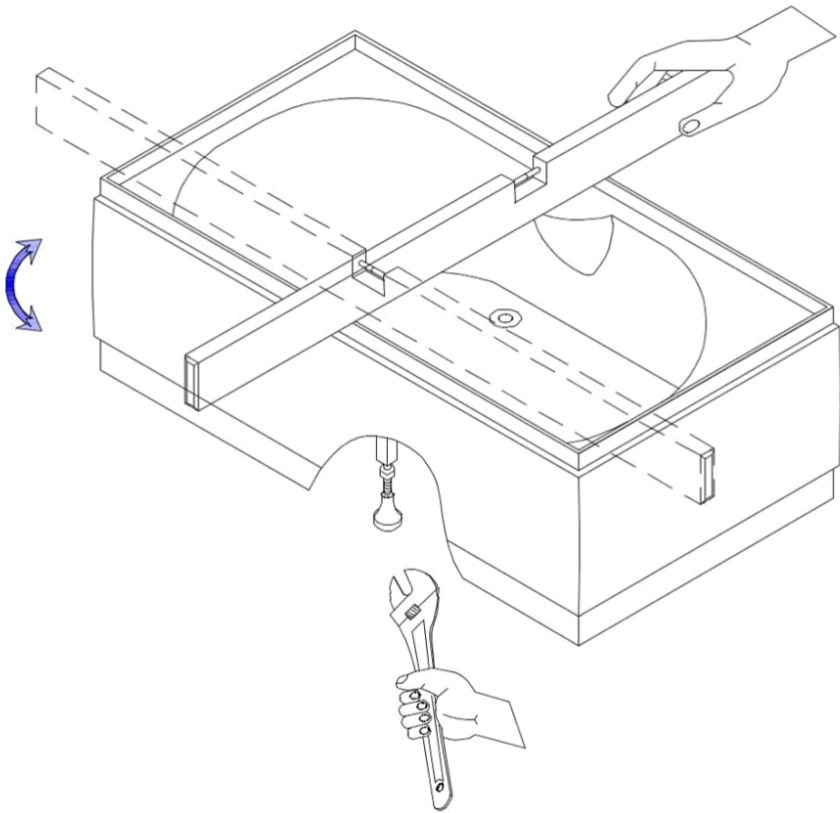
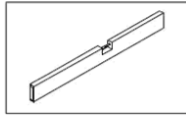
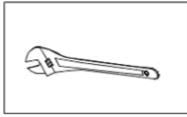



X2



X1



X1



ST4*16

X8

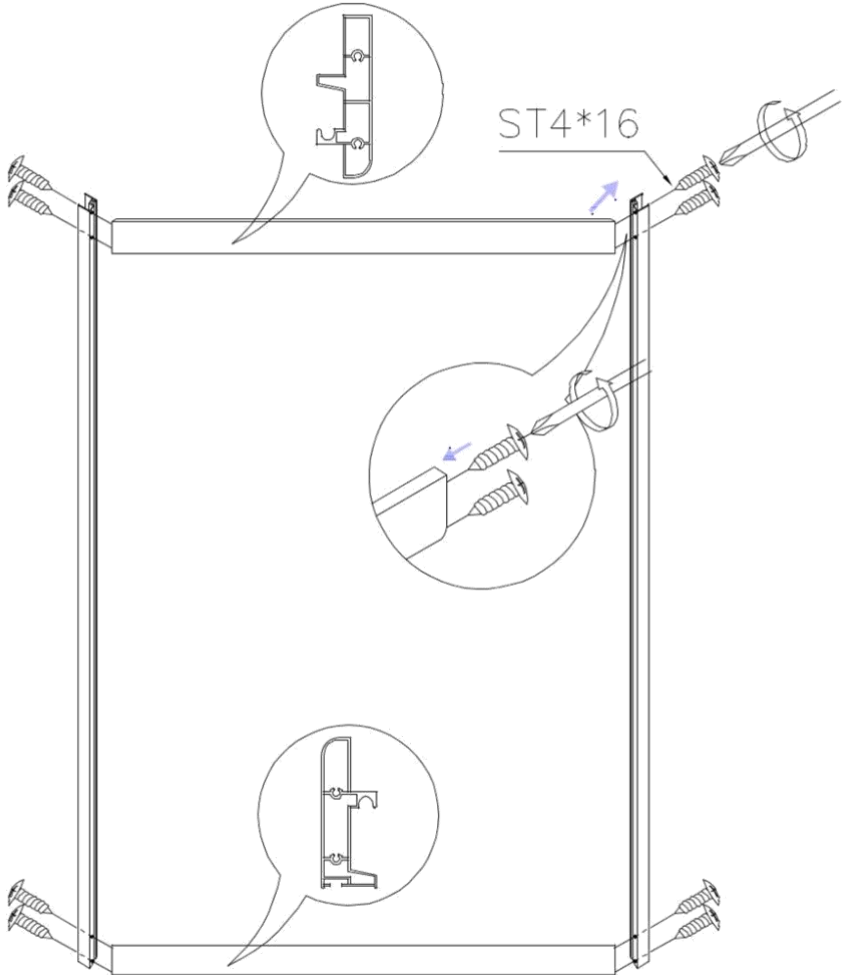

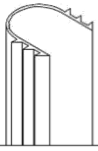

X2



X2

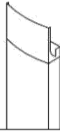

X2



ST4*16

X4

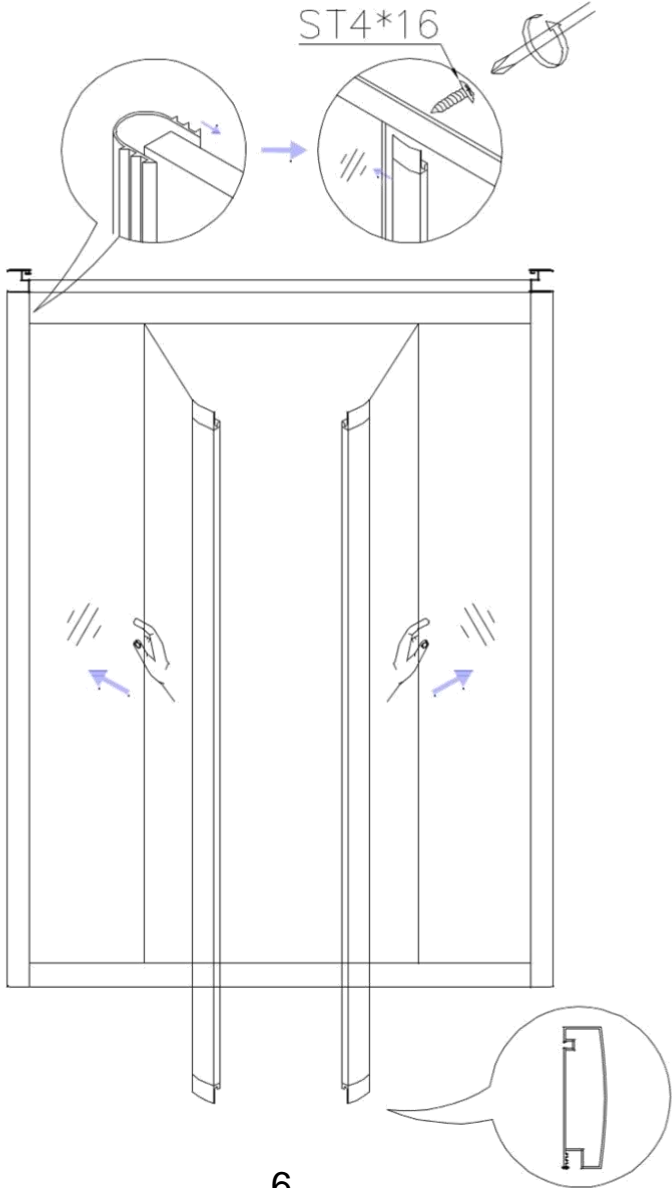



X8

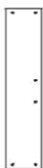

X2

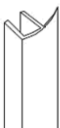

X2

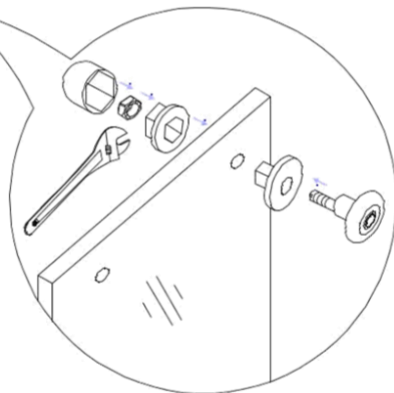
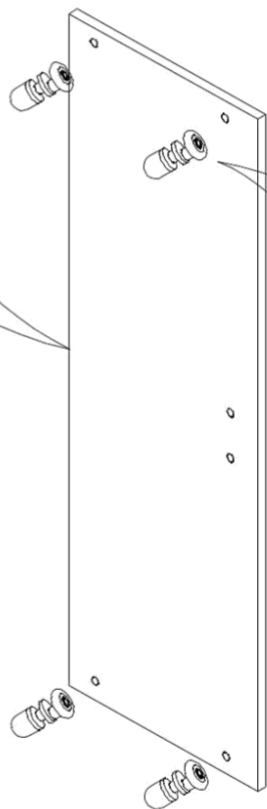
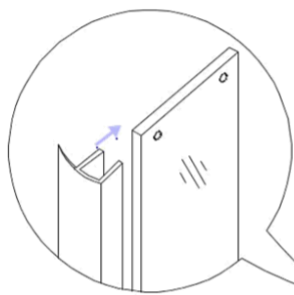
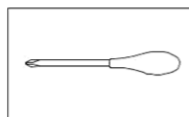

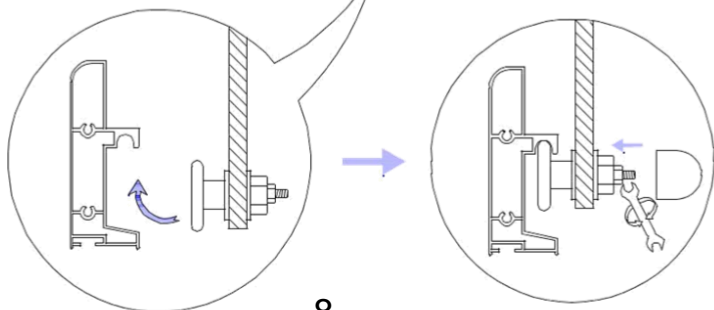
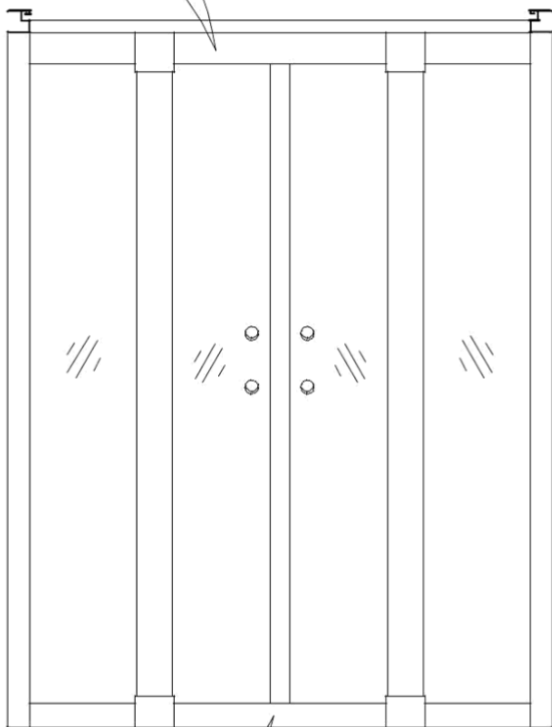
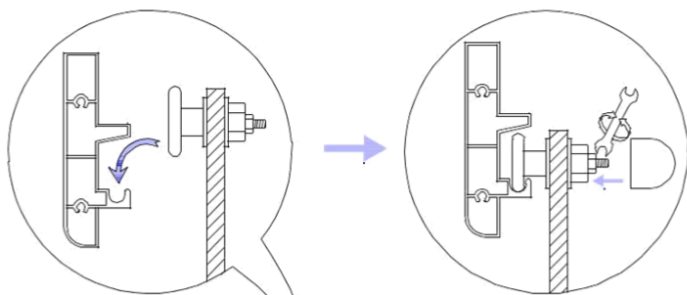

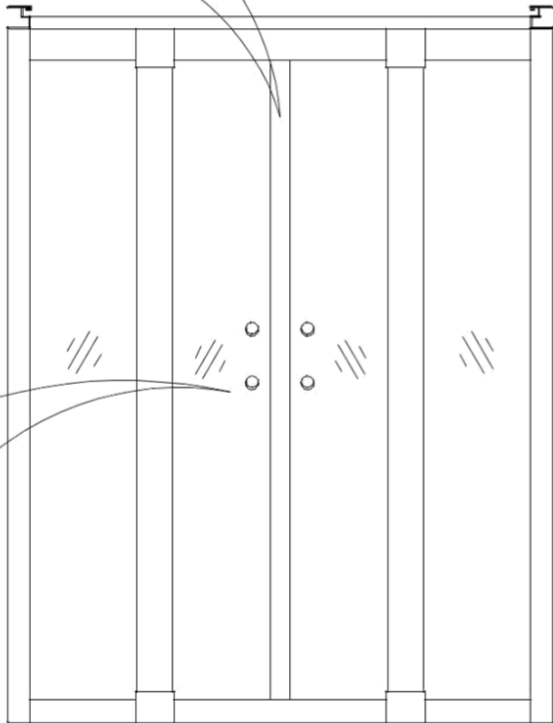
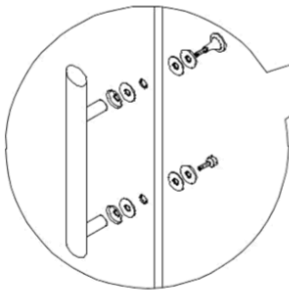
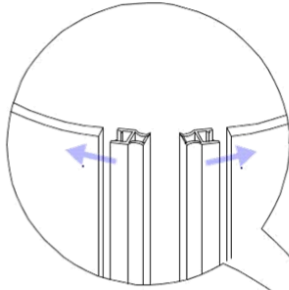
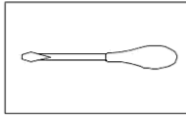
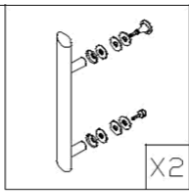
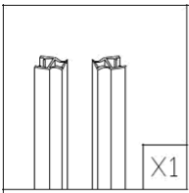

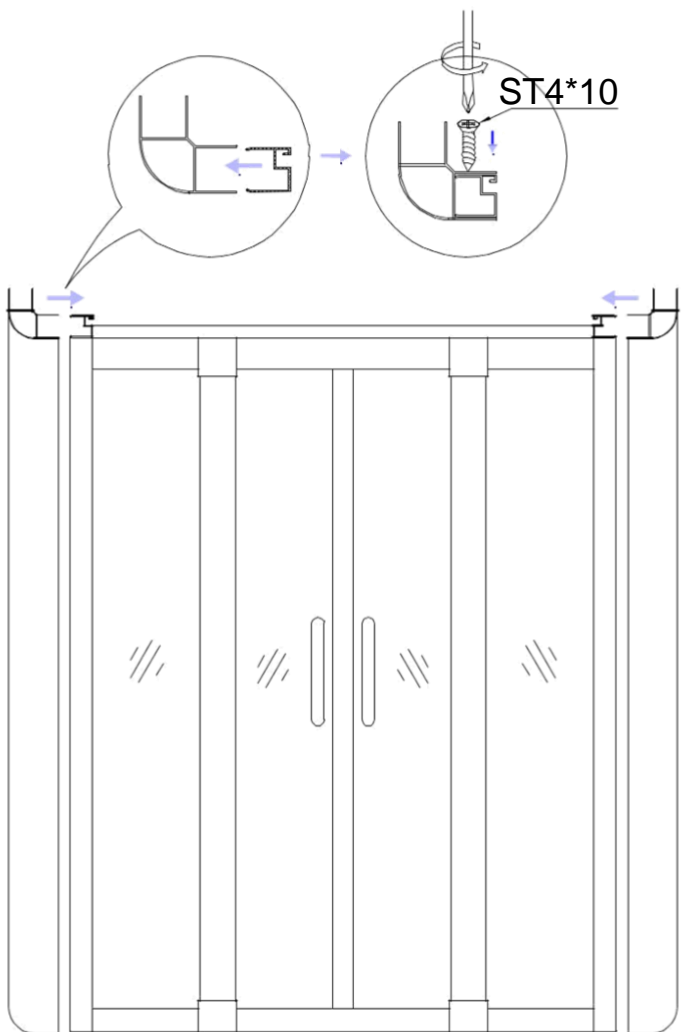
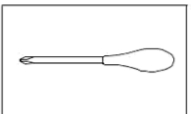
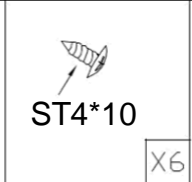
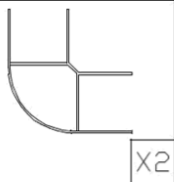



X1



X1



ST4*10

X6

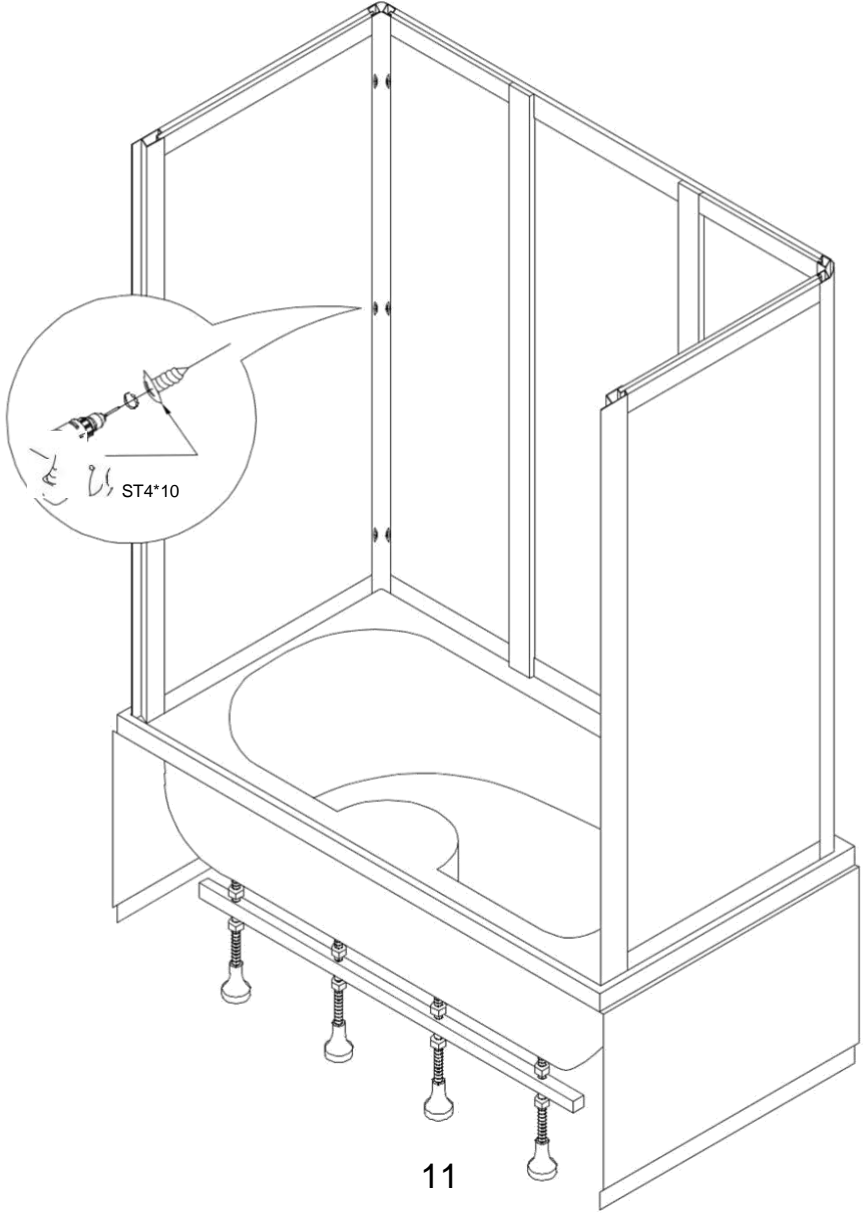

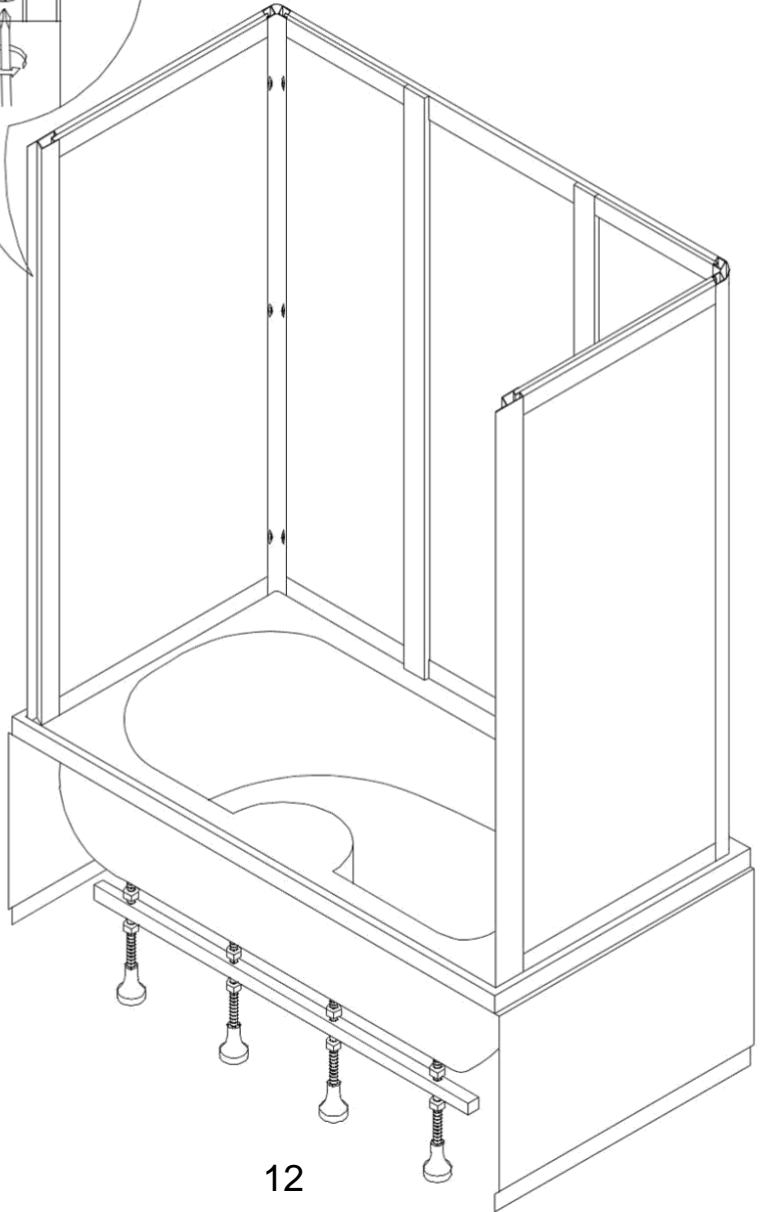
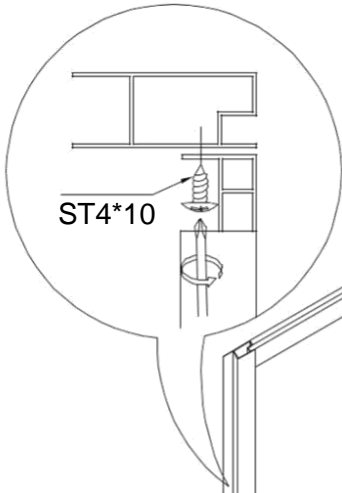
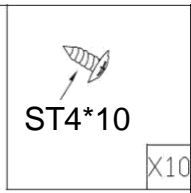
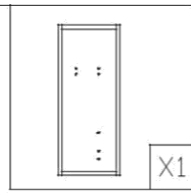
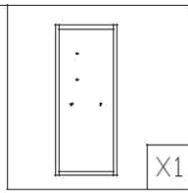

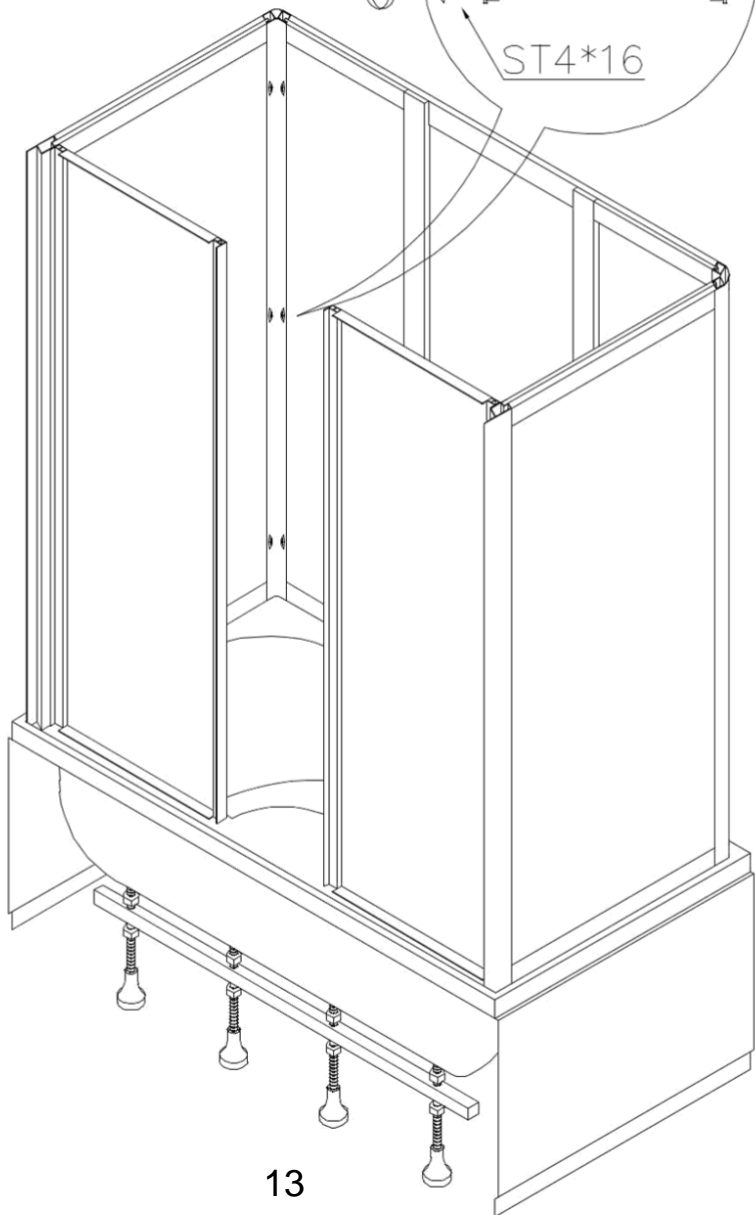
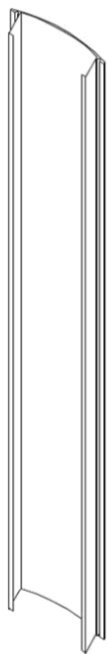
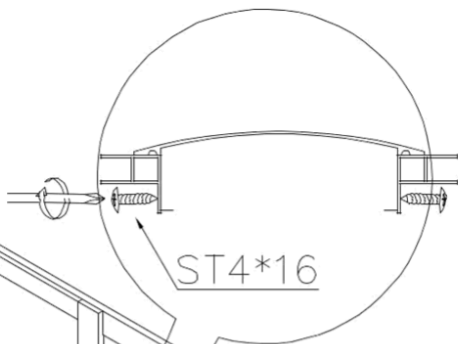
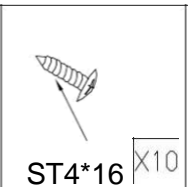
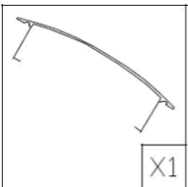



ST4*20 XP

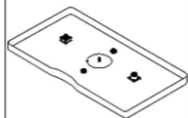

X1

4-ST4*20

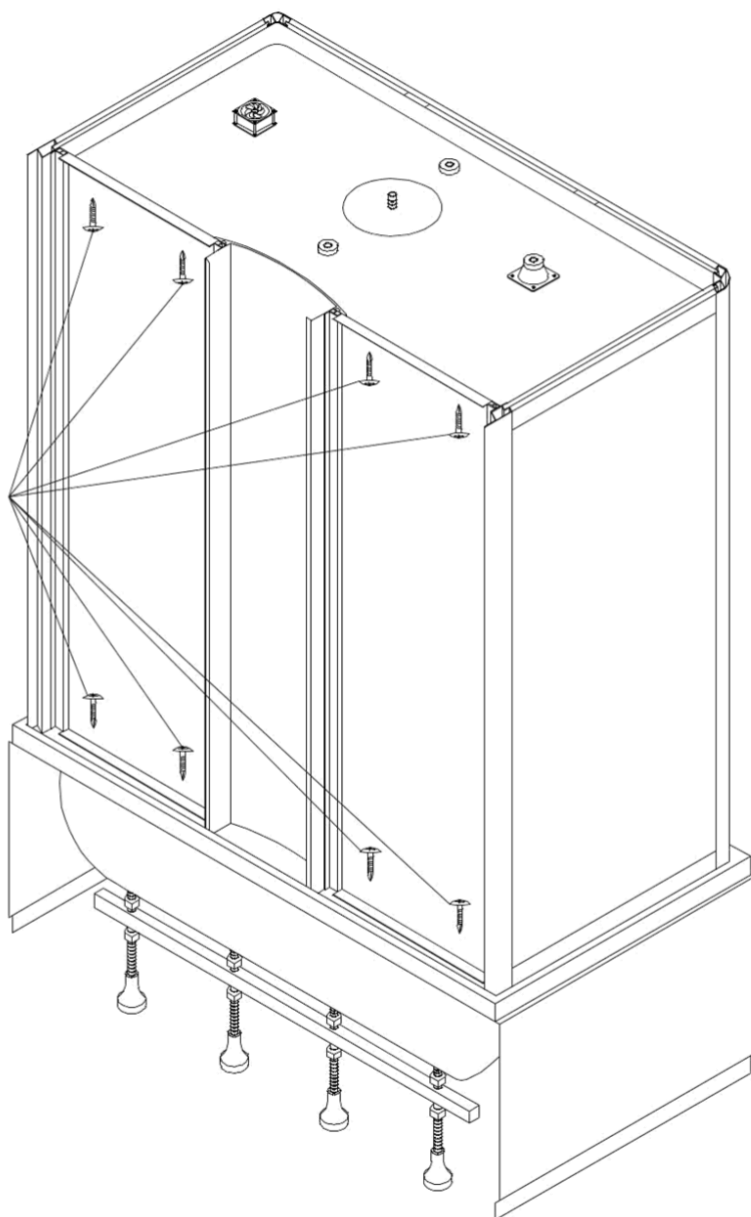

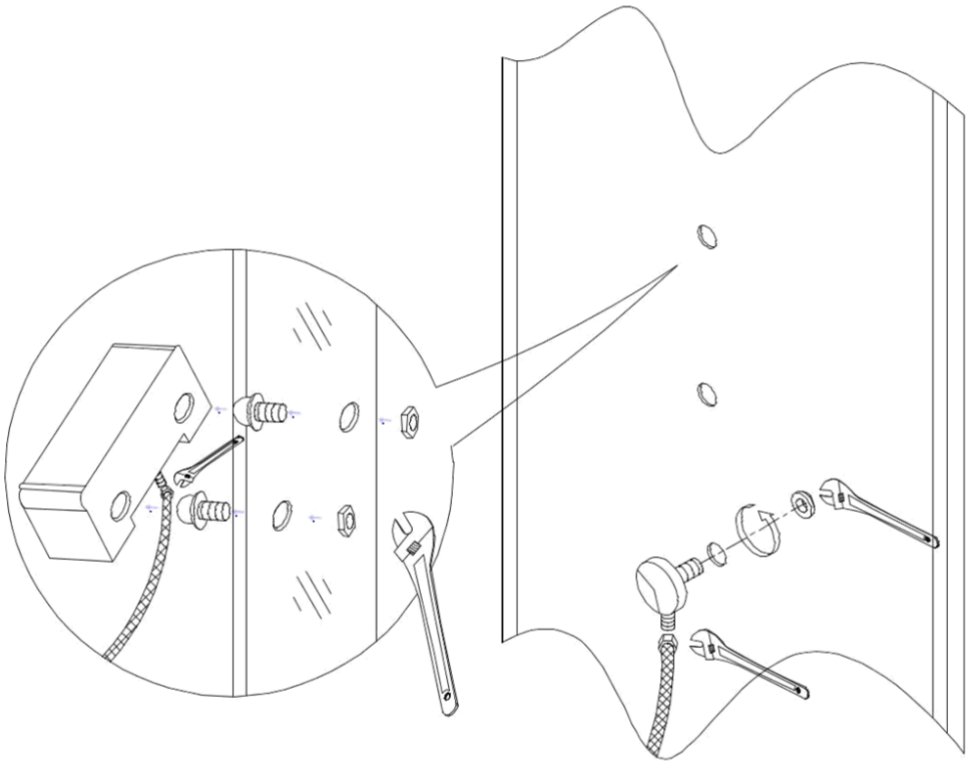
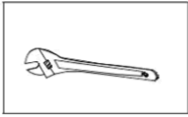
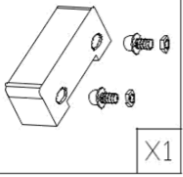

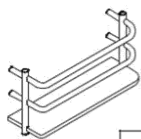

X1

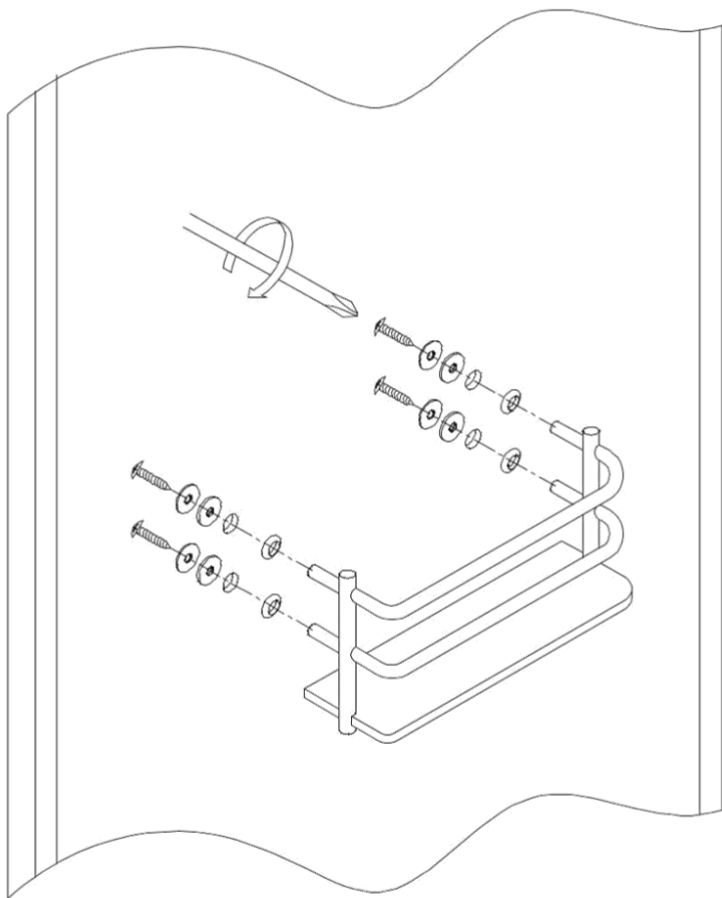
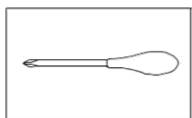



X1



X1



X1

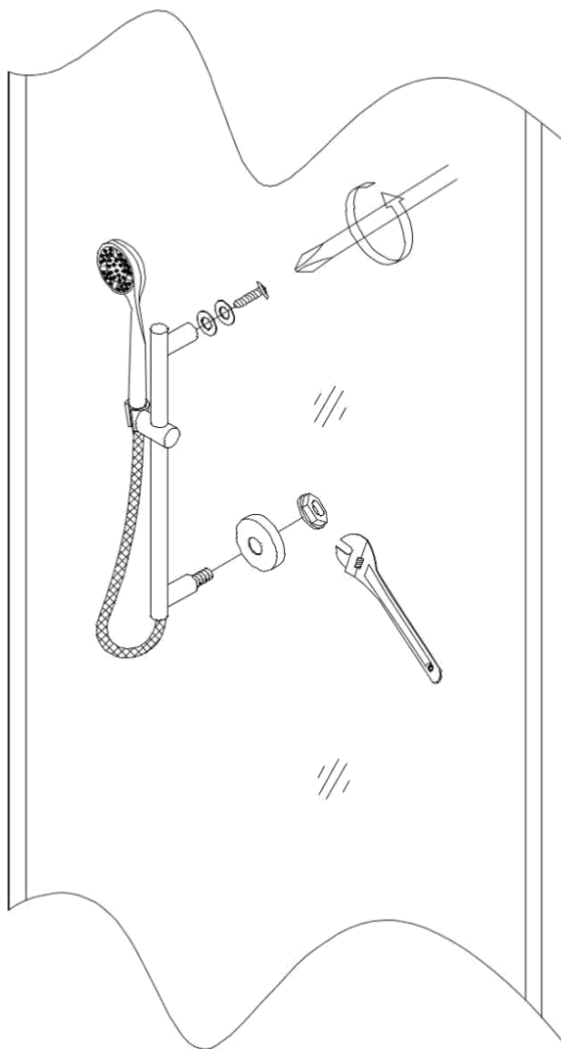
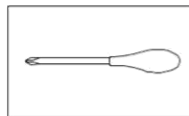

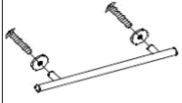

X1

